

FAN SOLUTIONS FOR ALL APPLICATIONS

THE PROGRAM

REGAL®

THE COMPANY

For anything to do with fans you should speak to us first. We have been manufacturing fans and related components for more than 60 years.

No matter where these fans are going to be used, with nine manufacturing sites and over 30 branches we are always close at hand. Across the world we can offer you personalized advice and provide just the right fan solution for your application.

Nicotra Gebhardt® fans from Regal are synonymous with high quality. Millions of them perform their duties reliably throughout the world in the most varied of application areas.

Regal facilities involved with design and manufacture of Nicotra Gebhardt fans are ISO 9001 certified. The laboratories have AMCA accreditation which is particularly stringent. AMCA develops and monitors standards and certifications for ventilation equipment. The seal is a sign of particularly high quality recognized all over the world.



Headquarter in Italy, Nicotra Gebhardt S.p.A



Headquarter in Germany, Nicotra Gebhardt GmbH

Nicotra Spa started manufacturing centrifugal fans in the early 60s. By providing suitable solutions to the market requirements Nicotra quickly became a market leader for high-quality small fans for industry. In 2005 Nicotra merged with the long-established German company, Gebhardt Ventilatoren.

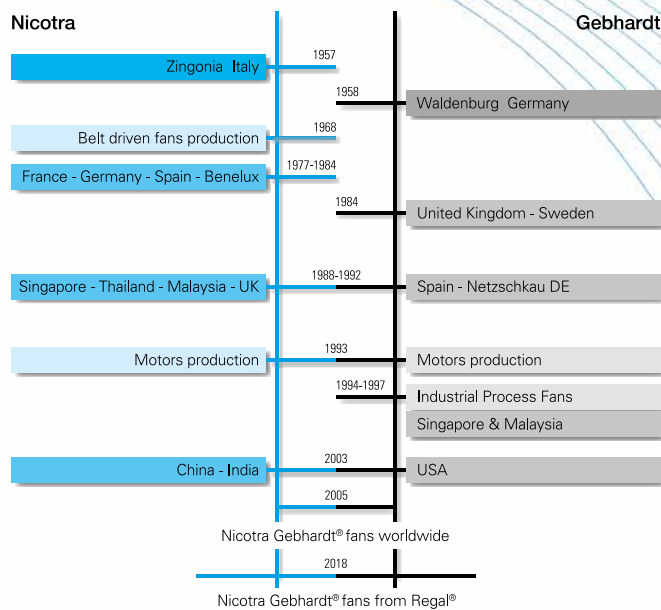

Wilhelm Gebhardt Bau lufttechnischer Geräte, founded in 1958, started with the manufacture of fan concept which was innovative at the time - direct-driven centrifugal fans with external rotor motors. The years that followed were marked by continuous development of new fan product ranges on the basis of unique technological innovations.

A LONG TERM STRATEGY

Technical expertise gained over decades in aerodynamics, acoustics as well as drive and control technology guarantees the efficient combination of the most modern components.

Whether with or without a housing, with belt or direct driven, with adapted impeller technology or, on request, with highly-efficient permanent magnet motors (EC) from a wide range of options, we provide our customers with the right fan solution – matches the operating point and no compromises with regard to efficiency and energy saving.

Ready for ErP 2020 and beyond: Fans have to achieve higher and higher levels of efficiency. This means higher performance with less power. The binding requirements for this are specified in the ErP Directive (Energy Related Products).

The new generation of our fan modules has already reached motor efficiency levels up to IE5 – going well beyond the specifications required in the future. As proposals are already being discussed for further raising the minimum efficiency level, so it is expected that in 2020 or sometime after that, there will be even higher requirements.

An appropriate solution for every requirement. Fan solutions for:

- Ventilation and air-conditioning
- Roof and smoke extraction
 - Cleanroom applications
- Industrial and process applications
 - Customised applications

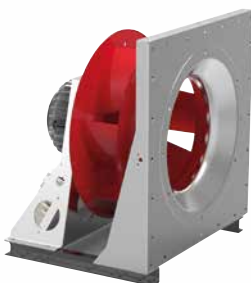

RLM Evo®
with internal rotor motor (PM/EC) and integrated electronics



PFP
with external rotor EC motor and integrated electronics



DDMP
Scroll casing with direct drive and forward curved blades - double inlet integrated electronics



RQM MultiEvo
with internal rotor motor (PM/EC) and integrated electronics



RDP
Scroll casing with direct drive and backward curved blades - double inlet integrated electronics

AN APPROPRIATE SOLUTION...

Fans with or without housing – the right solution for air conditioning systems:

In air conditioning units in recent years, more and more double inlet centrifugal fans with spiral housing have been replaced with often so-called plug fans. Plug fans, i.e. centrifugal fans without housing, could always be improved in the way they operated. But the theoretical maximum for improvements has largely been reached. As the spin of the flow at the impeller discharge, which inevitably occurs through the energy conversion in the impeller, cannot be avoided as wastage.

The advantages of the plug fans are their compact, simple construction and their direct drive. In this case, the impeller is mounted directly on the rotor of the motor. Depending on the concept, with external rotor motors, the aerodynamic efficiency will be negatively affected, as the rotor of the motor constitutes an obstruction to the impeller flow to a greater or lesser extent. This means that in the whole system, lower levels of efficiency are achieved than with technologically-comparable components with internal rotor motors.

Classic housing fans convert the dynamic pressure component of the spin at the impeller outlet into static pressure. The discharge flow is directed in the direction of flow. In this way, higher levels of efficiency can still be achieved with the housing fans with backward curved blades.

The advantages of housing fans with forward curved blades come into their own where space is tight with low pressures and high flow rate.

In order to combine the advantages of both types of fan construction, a completely new innovative fan concept has been developed, which, in compact form, causes a spin recovery using multi-spiral baffle plates and, therefore, achieves enormously improved levels of efficiency, without additional power wastage.

Depending on the conditions and the specified operating point, you may choose a different specific fan type. In general, for any fan type, there should be sufficient installation space available in order to minimize the wastage in the inlet and discharge outlets in the air conditioning unit. This is the only way, when selecting highly-efficient fan systems, that you can also achieve high levels of system efficiency and fulfil the efficiency requirements for air conditioning units properly.

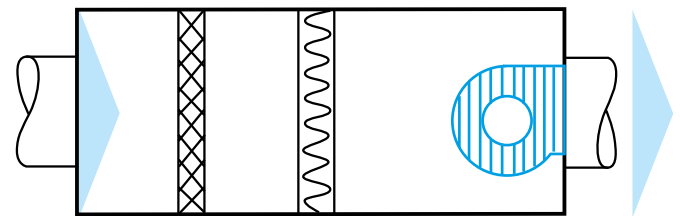
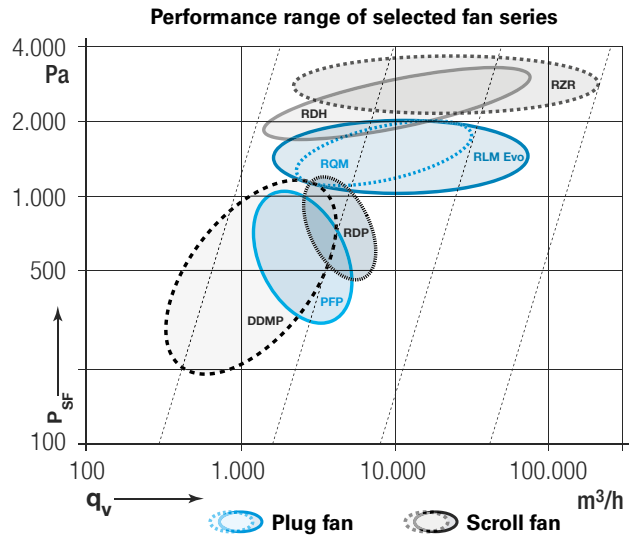

Air handling unit with backward-curved fan with scroll

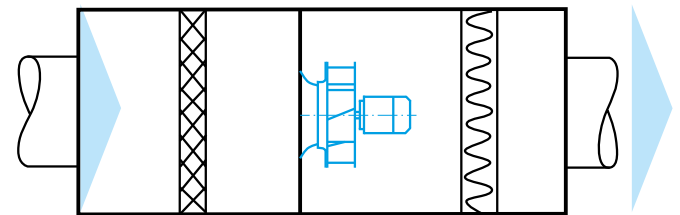

Air handling unit with plug fan

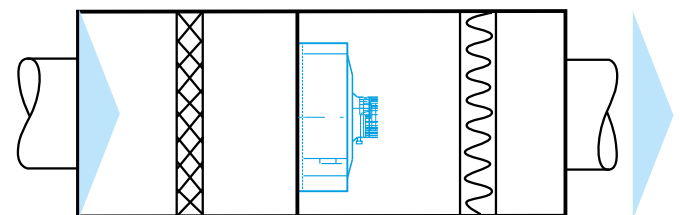

Air handling unit with hybrid fan

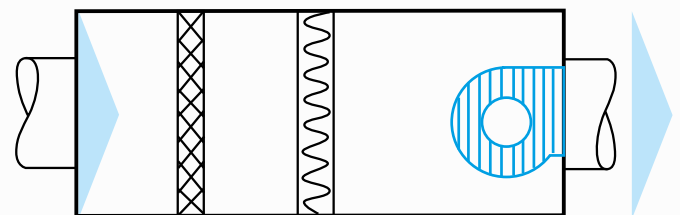

Air handling unit with forward-curved fan with scroll

...FOR EVERY REQUIREMENT



SCROLL FANS (BACKWARD-CURVED)

- Extremely high output range for air volumes and maximum pressure
- More cost-effective operations with PM/EC motors
- High system efficiency above all with higher pressures.



PLUG FANS

- Very low maintenance required
- Compact solution: Easy installation and maintenance
- Very high system efficiency in the medium pressure range
- Low noise level
- With internal or external control electronics
- Low space requirement



HYBRID FAN

- Very low maintenance required
- Compact solution: easy installation and maintenance
- Outstanding efficiency levels
- High pressure level
- Low noise
- Low space requirement



SCROLL FANS (FORWARD-CURVED)

- Compact design with minimum space requirement for a given duty
- Optimised for operation with low pressure and high volume flow-rate
- Extremely low noise level and low-frequency content
- Best energy efficiency when driven with integrated EC motor and driver

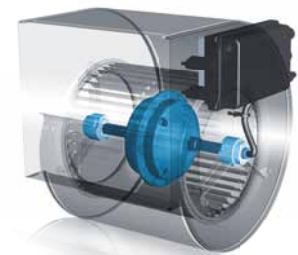
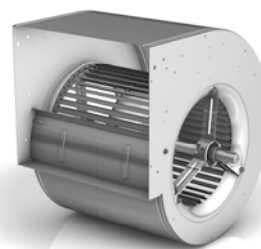

BELT DRIVEN CENTRIFUGAL FANS

Nowadays there is a great choice of different fan ranges available for everybody who has to select fans for a ventilating and air-conditioning system. Every execution has been optimised to its strengths. Our extensive product range offers the opportunity to find just the right fan for every application. Furthermore, we provide appropriate documentation and a fan selection program. Our fan selection programme proSELECTA II allows you to configure your own individually designed fan. What's more, you will get a complete documentation package with prices, technical data, dimensions, specifications and accessories.

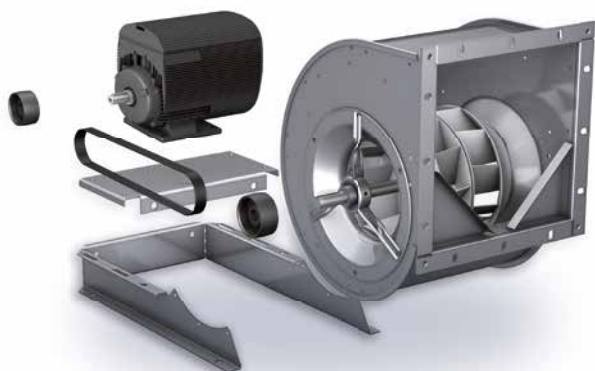
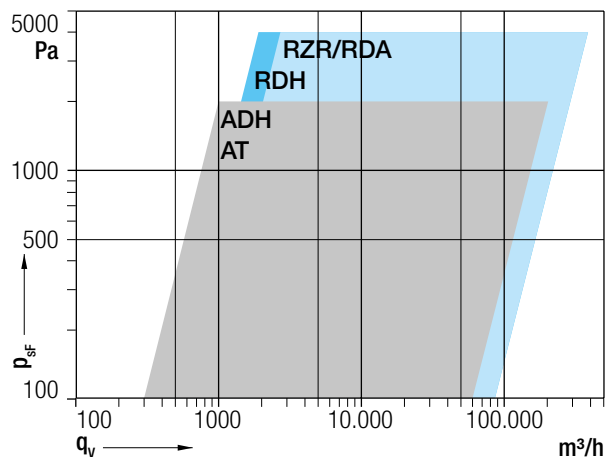

The efficient fan technology with scroll casing and airfoil blades

It's not difficult to make a centrifugal fan for an air conditioning unit a few euros cheaper. But to design it in a way that it saves valuable energy during operation is a real technological challenge. In this respect, our rotavent impeller continues to provide the technology with the highest level of system performance and, as a consequence, the best solution where energy efficiency counts.

RZR / RDA

Belt driven centrifugal fan with double inlet. Wide range of applications even for high pressures. High degree of performance density at best efficiency.

- Low noise level thanks to the blade profile, blade positioning and the V-cut off
- Easy and reliable fan configuration using our fan selection programme
- Impeller sizes from 200 to 1600 mm
- Air volume up to 300,000 m^3/h
- Pressure up to 3,500 Pa

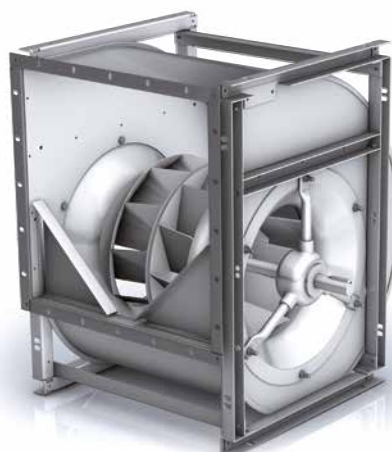



RDH

Belt driven centrifugal fan with double inlet. The ideal and cost effective fan for requirements in ventilating and air-conditioning systems. High flow rate, high pressure and high efficiency.

- Twin fan arrangement series RDH-G2
- Single inlet centrifugal fan series RSH
- Impeller sizes from 180 to 1000 mm
- Air volume up to 290,000 m³/h
- Pressure up to 3,500 Pa

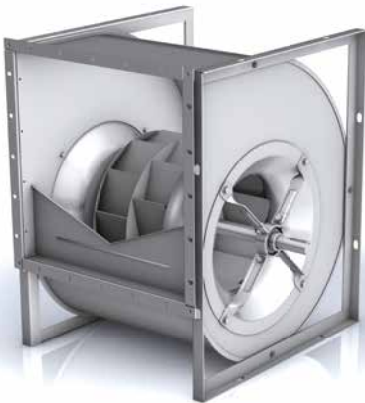

ADH / AT

Belt driven centrifugal fan with double inlet. The ideal and versatile fan, tried and tested a thousand times over for many standard applications of ventilating and air-conditioning systems. Impeller with forward-curved blades. High flow rate, low pressure, low noise level. Galvanised shaft, various bearing solutions.

- Available as twin- and triple fan arrangement
- Impeller sizes from 160 to 1000 mm (series AT with inch dimensions from 7/7 to 30/28)
- Air volume up to 120,000 m³/h
- Pressure up to 2,200 Pa



DIRECT DRIVEN CENTRIFUGAL FANS

With its Nicotra Gebhardt fans, Regal offers the most extensive product range of standardised direct driven centrifugal fans with and without spiral (plug fans). The range contains single and double inlet fans with different impeller types (backward and forward-curved blade geometries) and different drive technologies. The fans can be driven by IEC motors or external rotor motors, using AC or brushless DC technology, built-in, add-on or coupled; with stepless or stepped speed control, or pole changeable. We offer a wide range of direct driven centrifugal fans for every requirement.

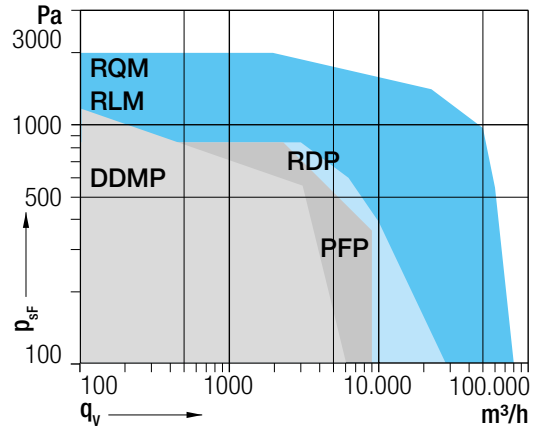

DDMP

The new DDMP is driven by a new and particularly energy efficient compact EC motor. These innovative motors achieve higher efficiency, and therefore cost less to operate, than traditional AC motors in every application.

- Compact solution, top rating efficiency, low noise level, high reliability
- No configuration needed
- Motor input power from 1.1 kW up to 2.6 kW
- Air volume up to 6,000 m³/h



DD / DDM

The DD and DDM series of double-inlet forward-curved fans are driven, respectively, by conventional internal-rotor and by advanced external-rotor AC motors. They are the entry-level types of forward-curved fans for incorporation in HVAC&R equipment.

- Compact and quiet in operation
- Extensive range of sizes and power levels
- Wide variety of AC motors, 1-Ph or 3-Ph, from 45W to 4 kW
- With open or closed frame motors
- Motors with multiple-speed windings, voltage-controllable or suitable for inverter drive.

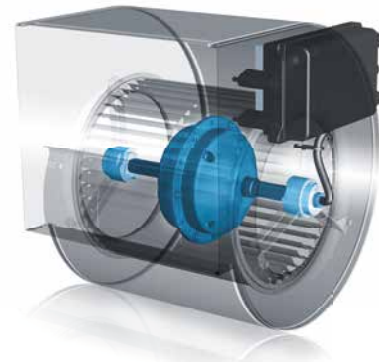

RDP

The fifteen year success of our RDH belt driven fans is now combining with the more recent success of the high-efficiency drive system. DDMP products. A new lightweight aluminium impeller is the additional innovation of this project. RDP is a single drop-in unit, integrating fan, motor and power control unit.

- Lower installation, operational and maintenance costs
- New high efficiency permanent magnet motor
- New compact and streamlined motor design
- High intensity neodymium magnets
- Reduced aerodynamic losses
- Max. motor power 4 kW
- Impeller sizes: up to 400 mm available, up to 630 mm under development





PFP (RLE)

The PFP, with an outstanding combination of efficient drive system and aerodynamics, is the ideal solution for medium-pressure applications. With lightweight aluminium impeller, optimised for medium pressure applications. Low interference loss with fan enclosure.

- External rotor motor (EC)
- Max. motor power 4 kW
- With integrated electronics
- Impeller sizes up to 630 mm

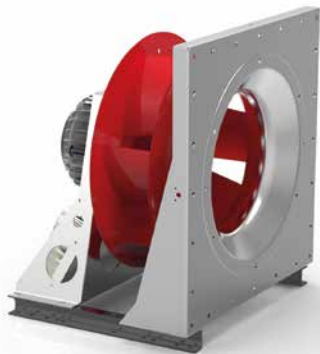

RLM Evo®

The new generation of fan modules already now reaches motor efficiencies up to IE5. With integrated electronics or frequency inverter.

- Evo impeller technology
- IEC standard motor/
PM/EC motor technology up to IE5
- Max. motor power 18/45 KW
- Impeller sizes 280 to 900/1250 mm

RQM MultiEvo

The new RQM MultiEvo combines the compact design of plug fans with the benefits of traditional cased fans. In principle, it is a directly driven centrifugal fan with spiral shaped guide vanes. With integrated electronics.

- Permanent magnet motor (EC) up to IE5
- Impeller sizes from 315 to 900 mm
- Motor output from 1.4kW to 18kW
- Air volumes up to 40,000 m³/h
- Pressure up to 2,000 Pa

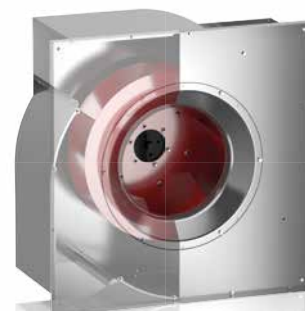

INDUSTRIAL PROCESS FANS

Process air fans are frequently an important component of machines and installations. In these applications, they assure functions that would not be possible without a well defined air flow. Of these specially developed, robust fans, there are several standard ranges and a number of customer-specific solutions.

Some examples of process ventilation

- Cooling of generators
- Drying agricultural products
- Ventilation of composting plants
- Extracting contaminated air from paint systems
- Circulating hot air in industrial furnaces

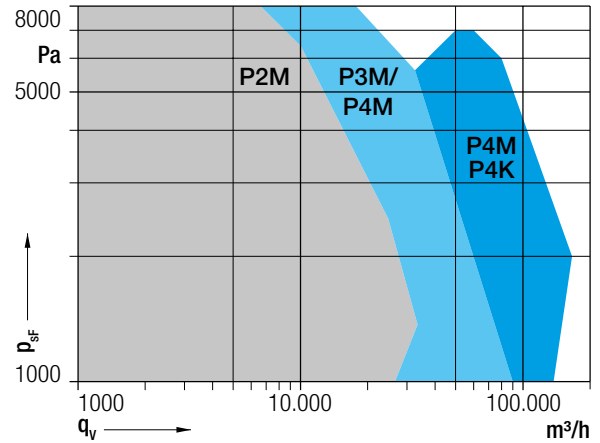

P2M

Compact and universal – the ideal direct driven fan for many process air applications. The ideal direct drive fan for many process air applications.

- Robust welded design
- Up to 300°C operation
- ATEX category 2 and 3; gas and dust
- Impeller sizes up to 900 mm
- Air volume up to 45,000 m³/h
- Pressure up to 8,000 Pa.

P3M

Compact and universal – the ideal direct driven fan for many process air applications.

- Robust welded design
- Up to 300°C operation
- Impeller sizes up to 1,000 mm
- Impeller sizes up to 900 mm
- Air volume up to 90,000 m³/h
- Pressure up to 8,000 Pa.

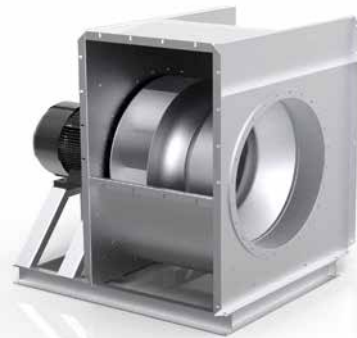

P4M

Powerful and versatile – the logical extension of the P2M/P3M series.

- Up to 300°C operation
- Impeller sizes up to 1,600 mm
- Air volume up to 180,000 m³/h
- Pressure up to 8,000 Pa.





Q2M - without scroll

Built-in system

Flat mounting plate, mounting frame, thermolock50 insulation, inlet cone loose or attached

Centrifugal impeller

Diameter 280 to 1,400 mm, backward-curved blades, welded, dust-repellent

Motor

Standard motor, B5 mounting to size 180, standard motor, B3 mounting from size 200, maximum motor size 315

Materials

Coated steel, hot-dip galvanised, stainless steel 1.4307, stainless steel 1.4571 on request

Medium

Media temperatures from -20°C up to +500°C, highly efficient thermal insulation thermolock50

ATEX

Prepared for category 2 and 3; gas and dust

Extensive range of accessories

Direct driven plug fans for industrial applications

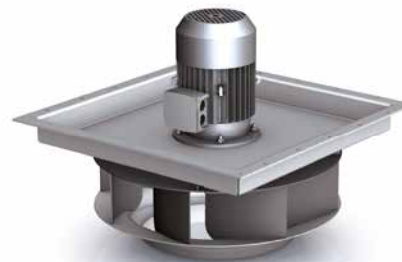
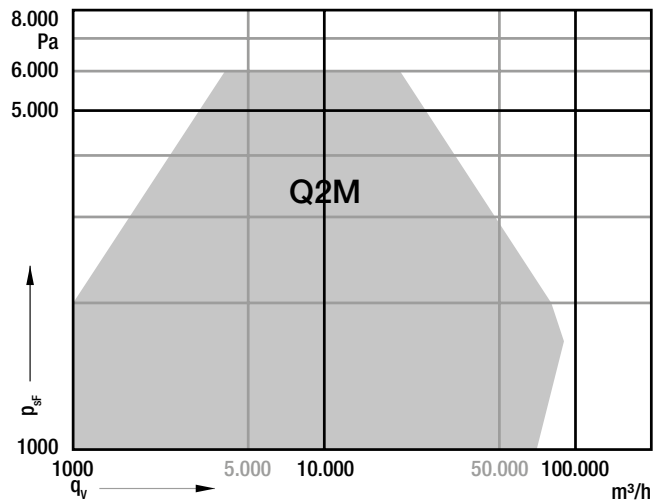

Q2M with highly efficient thermal insulation



ROOF EXTRACT FANS

While the majority of the industry here is just looking to more cost-efficient motors, we are looking at the whole picture. The impeller and housing design are specifically included in our concept in all our models. During development, we now rely almost entirely on asynchronous internal rotor motors that are available worldwide. And for good reason: fans with internal rotor motors are systemically superior to systems with external rotor motors. Systems that use external rotor motors have the disadvantage of the air flow being cut off by the motor in the impeller. In addition, IE2 and IE3 standard motors exceed the traditional voltage controllable external rotor motors in terms of efficiency. The same applies to even higher motor efficiencies. Even an impeller driven by a PM internal rotor motor exceeds the energy efficiency of systems with EC external rotor motors. And even if a service is required, motors and frequency converters can be easily replaced in a few, simple steps.

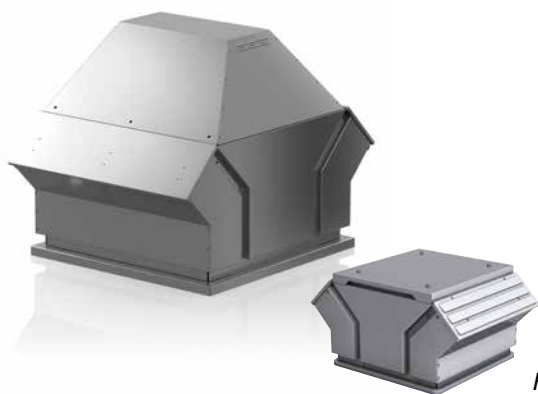
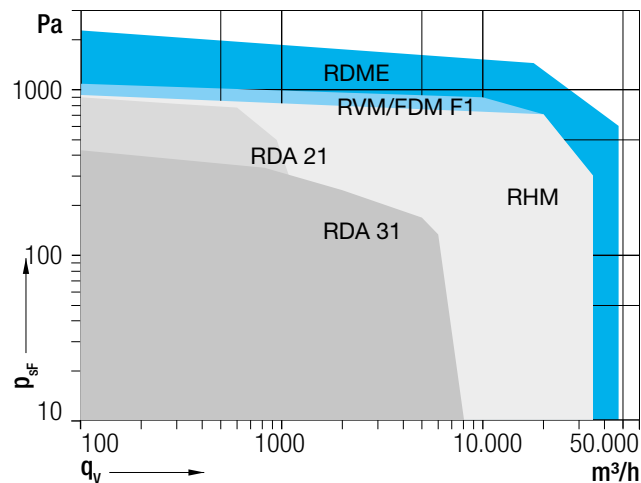

RDA with external rotor motor

RDME/RDA

- Centrifugal roof extract fan
- Vertical discharge
- Integrated back draught dampers
- With silence lining (RDME 32)
- E2/3/4/PM standard motor placed out of airstream
- Frequency inverter operation
- Integrated electronics

RVM/FDM

- Centrifugal roof fan
- Low noise level
- Vertical discharge
- With IE2/IE3 standard motor
- Frequency inverter operation

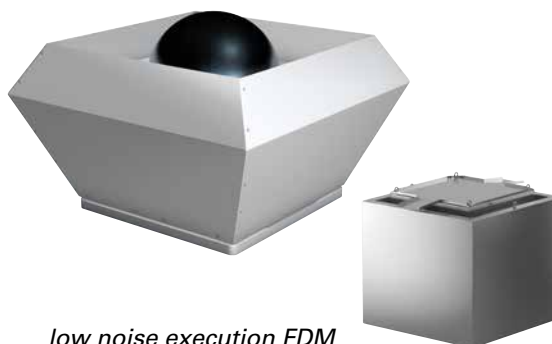

low noise execution FDM



RHM

- Centrifugal roof extract fan
- Vertical discharge
- With IE2/IE3-standard motor
- Frequency inverter operation

SMOKE EXTRACT FANS

Perfect smoke extraction, in the case of fire, not only demands absolute understanding of the techniques used – it also calls for an understanding of the nature of fire and the flow of fumes. We set standards in both aspects – by using computational fluid dynamics (CFD) to simulate the flow of smoke, for example. We thereby ensure maximum safety throughout any building – from the underground car park to the roof – and comply with all the statutory standards for building fire protection. We will assist you in the detailed planning and dimensioning of car park ventilation equipment, by means of a smoke flow simulation using CFD. With the help of CFD, the ideal smoke extraction and ventilation system – including the number and positioning of jetfans required – can be determined for each construction project, based on the legal requirements (GarVO).



RDM

Ensures a turbulence free discharge, suitable for smoke extraction in the case of fire up to **max. +600 °C - 120 minutes**, tested to DIN EN 12101-3, snow load class requirements SL 1000 assigned and CE certified. Assigned for mounting above heated and unheated rooms. Can be used as a standard ventilation fan up to max. +80 °C. Flow rate up to 58,000 m³/h. Pressure up to 2,000 Pa.



RER

Single inlet belt drive, suitable for smoke extraction in the case of fire up to **max. +400 °C - 120 minutes**, certified for installation outside of buildings, tested to DIN EN 12101-3, and CE certified. Can be used as a standard ventilation fan up to max. +80 °C. Optionally with insulation housing for installation inside of buildings, outside room with fire risk. Flow rate up to 150,000 m³/h. Pressure up to 3,000 Pa.

REM

Single inlet, with direct drive, suitable for smoke extraction in the case of fire up to **max. +600 °C - 120 minutes**, certified for installation outside of buildings, tested to DIN EN 12101-3, and CE certified. Can be used as a standard ventilation fan up to max. +100 °C. **REM BI** (not illustrated) with insulating enclosure, certified for installation inside of buildings – outside room with fire risk. Flow rate up to 31,000 m³/h. Pressure up to 1,500 Pa.



RGM

Centrifugal induction jetfan. Suitable for smoke extraction in the case of fire up to **max. 300 °C - 120 minutes**, tested to DIN EN 12101-3 and CE certified. Thrust up to 75 N.

FAN FILTER UNITS

Clean room processes call for the most advanced ventilation technologies that match the specifications of the building infrastructure. Thereby the filter fan units are the key elements in clean room ventilation systems. Nicotra Gebhardt® filter fan units (FFU) offered by Regal® with their perfectly matched components are designed for various kinds of industrial areas requiring clean room technology. Starting from standard FFU design, our team of experts implements the specification for your special project.

Simple handling: Controlling and monitoring of your FFU networks.

The core element of the system solutions we developed are the control centres for parameterisation and monitoring of your FFU networks on the basis of various RS485 interfaces (G-bus/Modbus RTU). We can optionally offer you three different components for actuation according to requirements:

- PC control centre for actuation of up to 500 FFUs per Ethernet RS485 Gateway
- Handheld FANCommander 100 for actuation of up to 100 FFUs
- Mini control centre FANCommander 200 for actuation of up to 200 FFUs. New software and hardware features suitable for assembly on the wall or installation in a switch cabinet

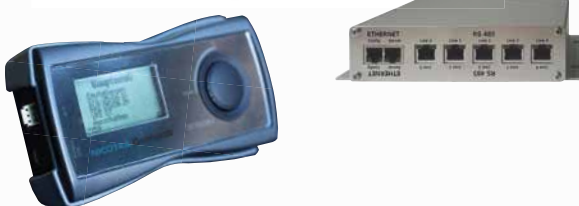

Main dimensions of the standard sizes

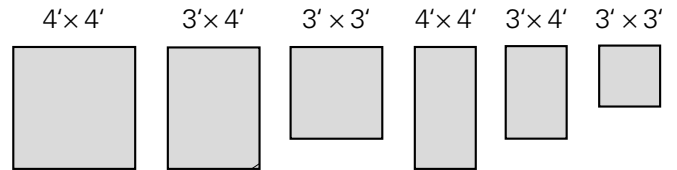

Using standard sizes to adapt for special building requirements

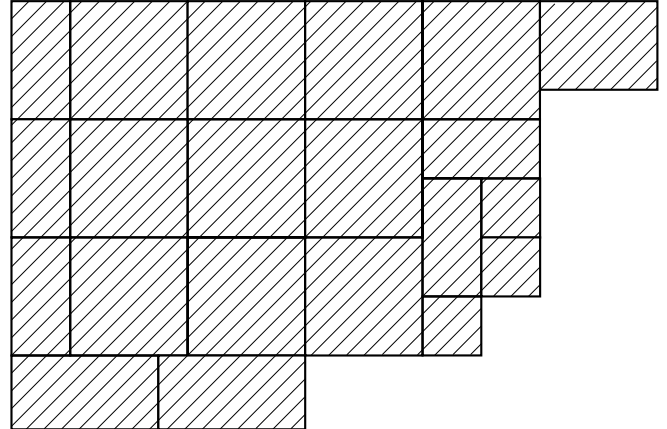

Fan Filter Units (FFU)

Construction materials:

- Galvanised steel
- Powder coated steel
- Aluminum
- Aluminum zinc coated
- Stainless steel

Network Topology:

- GBUS
- Modbus-RTU
- LONWORKS®*
- Analogue 0-10V

Motor:

- Single phase
- Brushless DC technology
- UL listed

Accessories

- Pressure measurement connection Ø 6 mm
- Aerosol measurement/application connection Ø 8 mm
- Swirl diffuser
- Perforated guide plate
- Air cooler
- Pre filter
- Flexible connection round/square
- Connecting flange round/square
- Hanger points



The new RHP MultiEvo

As simple as it is ingenious: The new RHP MultiEvo houses new, unique outlet guide systems with spiral geometries. Designed for perfect interaction, the impeller, motor and integrated electronic components of the RHP MultiEvo greatly exceed the energy savings of any other traditional EC filter fan unit.

The practical advantages

New technology:

Aerodynamic air guides optimise flow conditions

Excellent energy savings:

Over 60% efficiency thanks to the interaction of the system components

Optimised performance range:

Considerable increase in pressure for the same maximum speed and power requirements

Considerably quieter:

Noise levels up to 4 dB lower

Air distribution:

Maintained high level of uniformity

Reduced housing height:

Flatter for greater space savings



WORLDWIDE LOCATIONS

NICOTRA-GEBHARDT.COM

AUSTRALIA

Regal Beloit Australia Pty Ltd
19 Corporate Ave (PO Box 2340)
Rowville VIC 3178
Phone 1 300 888 853
Fax +61 3 9237 4050
E-mail SalesAUvic@regalbeloit.com

BELGIUM

Allée des Artisan,18
4130 Esneux
Phone +32 (0)42288580
Fax +32 (0)42288580
E-mail info@nicotra.be

CHINA

88 Tai'An Road, XinQiao, ShiJi, Panyu
Guangzhou 511450
PR CHINA
Phone +86 (0)20-2293 5700
Fax +86 (0)20-2293 5701
E-mail sales@nicotra-china.com

FRANCE

Leader's Park Bat A1
3 chemin des Cytises
69340 Francheville
Phone +33 (0)4 72 79 01 20
Fax +33 (0)4 72 79 01 21
E-mail ngfrance@nicotra-gebhardt.com

GERMANY

Gebhardtstraße 19-25
74638 Waldenburg
Phone +49 (0)7942 101 0
Fax +49 (0)7942 101 170
E-mail info.ng.de@regalbeloit.com

GREAT BRITAIN

Unit D, Rail Mill Way
Parkgate Business Park
Rotherham
South Yorkshire
S62 6JQ
Phone +044 01709-780760
Fax +044 01709-780762
E-mail sales@nicotra.co.uk

INDIA

Plot no 28F & 29, Sector-31,Kasna,
Greater Noida-201 308 U.P (India)
Phone +91 120 4783400
Phone +91 22 65702056 (Mumbai)
Phone +91 80 25727830 (Bangalore)
E-mail info@nicotraindia.com

ITALY

Via Modena, 18
24040 Zingonia (BG)
Phone +39 035 873 111
Fax +39 035 884 319
E-mail info@nicotra-gebhardt.com



MALAYSIA

Lot 1799, Jalan Balakong
Taman Perindustrian Bukit Belimbing
43300 Seri Kembangan
Selangor
Phone +603 8961-2588
Fax +603 8961-8337
E-mail info_malaysia@nicotra-gebhardt.com

NEW ZEALAND

Regal Beloit New Zeland Limited
18 Jomac Place
Avondale, Auckland 1026
Phone 0800 676722
Fax +64 9 820 8504
E-mail salenzth@regalbeloit.com

SPAIN

C/ Jamaica, 5
Apdo. Correos 5077
28806 Alcalá de Henares
Phone +34 918-846110
Fax +34 918-859450
E-mail info.es@nicotra-gebhardt.com

SINGAPORE

12 Tuas Loop
Singapore 637346
Tel: +65 6863 3473
Fax: +65 6863 3476
E-mail info_singapore@nicotra-gebhardt.com

SWEDEN

Box 237
Kraketorpsgratan 30
43153 Mölndal
Phone +46 (0)311302610
E-mail info.se@nicotra-gebhardt.com

THAILAND

6/29 Soi Sukawadi 2, Moo 4, Suksawadi Road,
Kwang Jomthong, Khet Jomthong,
Bangkok 10150
Phone +662 476-1823-6
Fax +662 476-1827
E-mail sales@nicotra.co.th

United States (USA)

Regal Beloit America, Inc.
200 State Street
Beloit, WI 53511
Mobile +1 608 224 9967
E-mail drew.donahue@regalbeloit.com

NICOTRA|Gebhardt®

Nicotra Gebhardt Germany

Nicotra Gebhardt GmbH
Gebhardtstraße 19-25
74638 Waldenburg (Germany)
Phone +49 7942 1010
Fax +49 7942 101 170
E-mail info.ng.de@regalbeloit.com
Web: www.nicotra-gebhardt.com

Nicotra Gebhardt Italy

Nicotra Gebhardt S.p.A
Via Modena, 18
24040 Zingonia (BG) (Italy)
Phone +39 035 873 111
Fax +39 035 884 319
E-mail info@nicotra-gebhardt.com
Web: www.nicotra-gebhardt.com

APPLICATION CONSIDERATIONS

The proper selection and application of products and components, including the related area of product safety, is the responsibility of the customer. Operating and performance requirements and potential associated issues will vary appreciably depending upon the use and application of such products and components. The scope of the technical and application information included in this publication is necessarily limited. Unusual operating environments and conditions, lubrication requirements, loading supports, and other factors can materially affect the application and operating results of the products and components and the customer should carefully review its requirements. Any technical advice or review furnished by Regal Beloit America, Inc. and/or its affiliates ("Regal") with respect to the use of products and components is given in good faith and without charge, and Regal assumes no obligation or liability for the advice given, or results obtained, all such advice and review being given and accepted at customer's risk.

For a copy of our Standard Terms and Conditions of Sale, please visit <https://www.regalbeloit.com/Terms-and-Conditions-of-Sale>. These terms and conditions of sale, disclaimers and limitations of liability apply to any person who may buy, acquire or use a Regal product referred to herein, including any person who buys from a licensed distributor of these branded products.

Regal and Nicotra Gebhardt are trademarks of Regal Beloit Corporation or one of its affiliated companies.

© 2019 Regal Beloit Corporation, All Rights Reserved. MCB19038E • Form# 10237E

REGAL®